

Triple Offset Butterfly Valve

Class 300 NPS 3" - NPS 32"

Flanges ANSI Class 300



Fig. 153F-553F

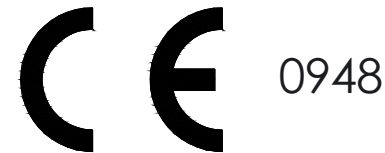
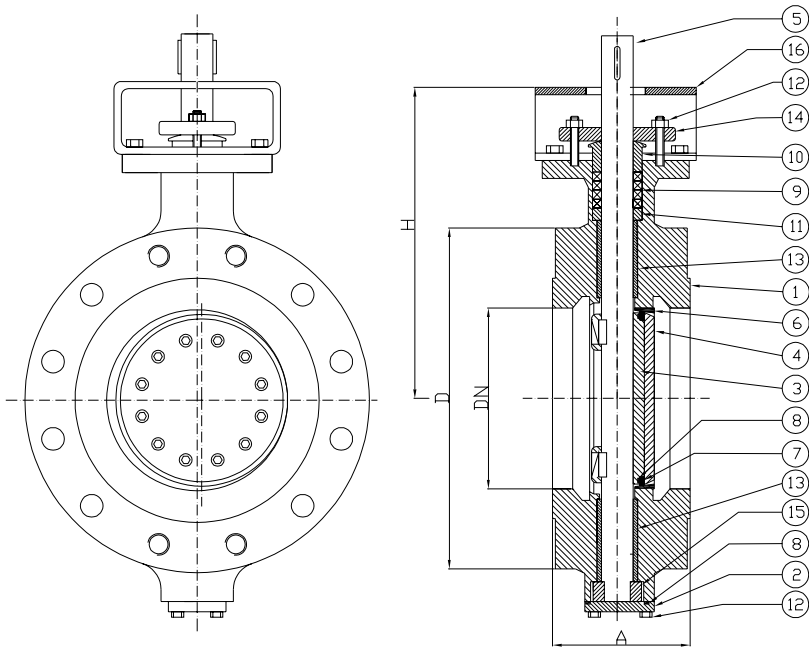

Standard features:

- Design ASME B 16.34
EN 12516
EN 593
- Face to face ISO 5752 series 13
EN 558-1 series 13
BS 2080 series 13
- Flanges ASME B 16.5 (EN 1759-1)
- Materials ASME B 16.34
EN 1503
- Bolts and nuts EN 1515-1
- Welding overlay AD-M HP 0
- Testing EN 12266
API 598
- Marking EN 19
- Certificates EN 10204

Optional versions:

- AD 2000 – A4
- TRD 110
- ATEX compliant
- TA-Luft
- ISO 15848
- With special devices