

Triple Offset Butterfly Valve

PN 100

DN 80 - DN 600

Butt Welding Ends type



Fig. 162B-562B

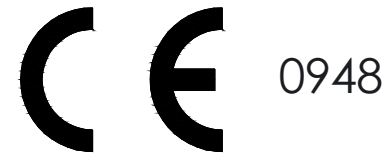
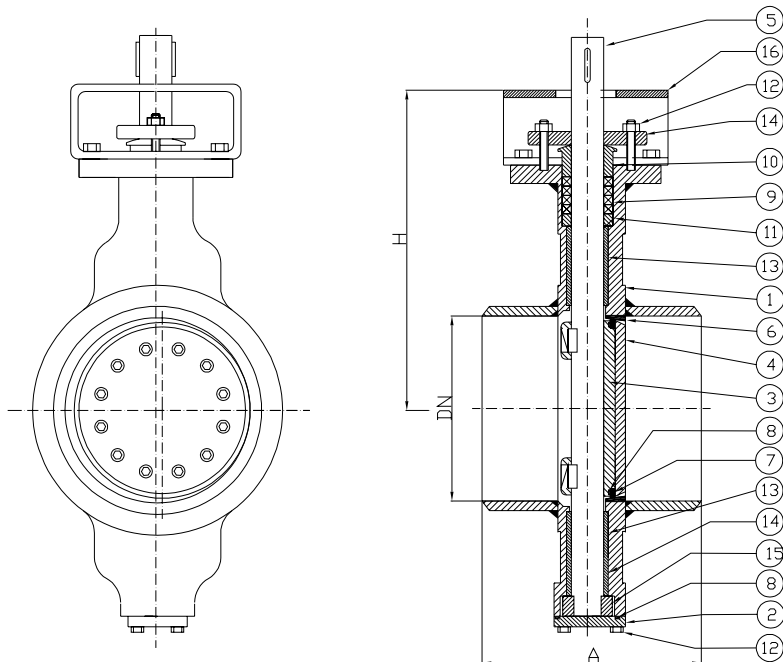

Standard features:

- Design EN 12516
EN 593
- Face to face EN 12982 series 66
- Butt welding ends EN 12627
- Materials EN 10025
EN 10028
EN 1503
- Bolts and nuts EN 1515-1
- Welding overlay AD-M HP 0
- Testing EN 12266
API 598
- Marking EN 19
- Certificates EN 10204

Optional versions:

- AD 2000 – A4
- TRD 110
- ATEX compliant
- TA-Luft
- ISO 15848
- With special devices