

Triple Offset Butterfly Valve

Class 600 NPS 3" - NPS 24"

Butt Welding Ends type



Fig. 163B-563B

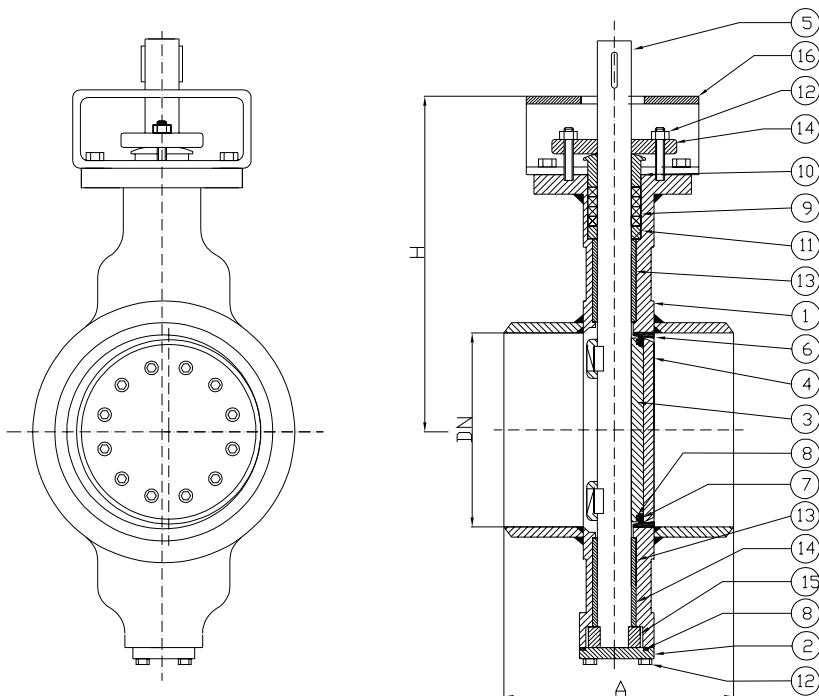

Standard features:

- Design ASME B 16.34
EN 12516
EN 593
- Face to face EN 12982 series 66
- Butt welding ends ASME B 16.25
- Materials ASME B 16.34
EN 1503
- Bolts and nuts EN 1515-1
- Welding overlay AD-M HP 0
- Testing EN 12266
API 598
- Marking EN 19
- Certificates EN 10204

Optional versions:

- AD 2000 – A4
- TRD 110
- ATEX compliant
- TA-Luft
- ISO 15848
- With special devices