

# Triple Offset Butterfly Valve

Class 600 NPS 3" - NPS 14"

Lug - single flange type



Fig. 163L-563L

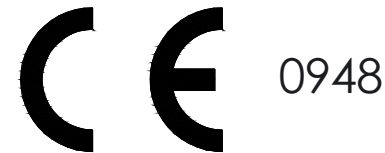
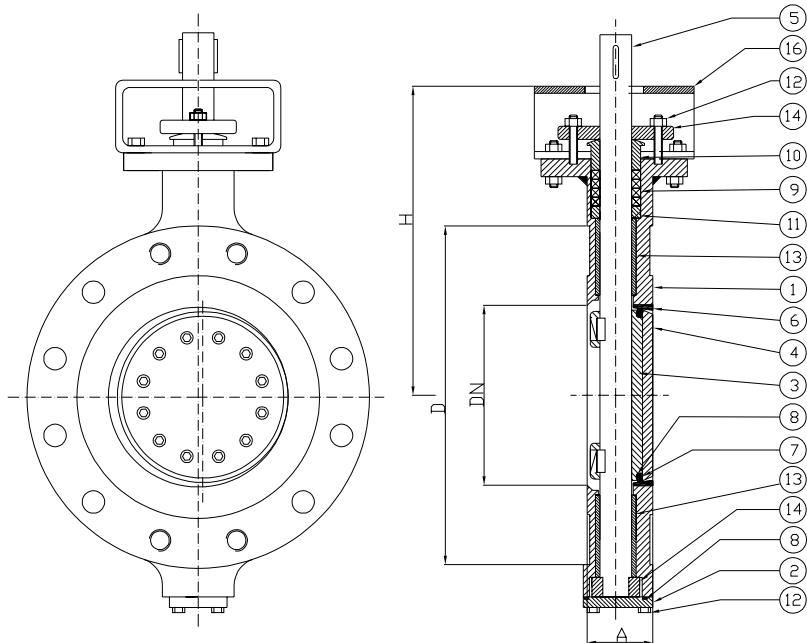

## Standard features:

- Design API 609  
EN 12516  
EN 593 (Fig. 3b)
- Face to face API 609 CL 600
- Materials ASME B 16.34  
EN 1503
- Bolts and nuts EN 1515-1
- Welding overlay AD-M HP 0
- Testing EN 12266  
API 598
- Marking EN 19
- Certificates EN 10204

## Optional versions:

- AD 2000 – A4
- TRD 110
- ATEX compliant
- TA-Luft
- ISO 15848
- With special devices
- All tapped holes (EN 593 Fig. 3d)
- Lightweight lug type (EN 593 Fig. 3a or 3c)